

# FEIGHNER

## BOAT LIFTS & DOCKS

### 1800boatlift.com

*Our Products • Your Memories*





# FEIGHNER BOAT LIFTS & DOCKS

## Statement of Warranty

### Boat Lift Warranty Details

- Feighner Boat Lifts & Docks will warranty all welds on Feighner Vertical Boat Lifts for a period of 15 years Limited Warranty.
- Feighner Boat Lifts & Docks will warranty all welds on Feighner Hydraulic Boat Lifts for a period of 5 years Limited Warranty.
- Cables are under warranty for 2 years.
- Cylinders and hoses are under warranty for 2 years. Customer is responsible for shipping and labor involved in replacing the warranty items.

### Dock Warranty Details

- Feighner Boat Lifts & Docks will warranty\* all welds on dock frames for the lifetime\*\* of the original purchaser. This does not include accessories.
- Feighner Docks are not intended for diving applications.
- All Decking warranty issues will be handled through Feighner with the aid of the decking manufacturers. Decking manufacturers determine their own warranty programs.

### General Warranty Terms

- All warranty issues are administered through the selling dealer with Feighner Boat Lifts & Docks acknowledgment.
- The warranty is for the original owner and not transferable.
- Feighner will warranty the entire structure of all Feighner Boat Lifts & Docks and accessories to the original owner for a period of 2 years when purchased new for residential use.
- All warranty items must be returned to Feighner Boat Lifts & Docks freight prepaid and the warranty item will be reshipped freight collect.
- Feighner Boat Lifts & Docks reserves the right to repair or replace any warranty item.
- Feighner Boat Lifts & Docks is not liable for damages or injuries as a result of misuse/neglect, installation/removal, or the purchase of inappropriate selection of style or weight capacity of one of our products.
- The warranty will be voided on any product that is left in a frozen body of water or water with ice movement.
- In the event that any Feighner Boat Lift & Dock product is used in brackish water, saltwater or acidic water, a 1 year limited warranty for Saltwater Use, shall take priority over the 15 year Limited/Lifetime warranty for Residential Use or Non-Residential Use.
- Feighner Boat Lifts and Docks is not liable for repairs or modifications to its products.
- Modifications void all warranties.
- Components obtained from other manufacturers and used in Feighner Boat Lifts & Docks products, will be covered under that manufacturer's warranty.
- Specifications are subject to change without notice.
- Feighner Boat Lifts & Docks will not warranty damage to aluminum, hydraulic or electric components caused by overload, corrosion, submersion, low voltage, misuse, or acts of God.

**\*War•ran•ty noun:** A legally binding guarantee attesting to the quality and durability of a product.

**\*\*Life•time noun:** The period of time during which an individual is alive.

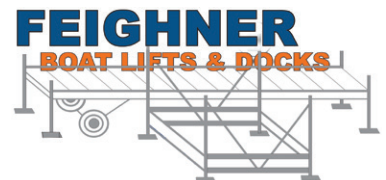

# About Us



CHARLOTTE, MICHIGAN

The Feighner Company (TFC) was initially started in 1969 as a small family farm in Nashville, MI. By 1973, the company had grown into a significant farming and custom hay baling operation farming hundreds of acres. In 1982, as the company continued to grow, a second building was constructed to house offices and a retail feed store on the family farm. In 1987, The Feighner Company became incorporated as a Michigan Corporation.

In 1990, Scott's father wanted to see which manufactured docks were available for purchase for the family cottages in northern Michigan, since the traditional wooden framed dock was failing. Scott located a rolling dock manufacturer that looked interesting and contacted them to purchase a dock. This quickly evolved into TFC selling products for that manufacturer.

Over the next several years, it became very apparent to Scott that there was a huge opportunity to manufacture aluminum docks and lifts to the highest standards available and supply an excellent warranty to the customer. Scott decided that if he was going to stay in the dock and boat lift business, he was going to make his own design modifications and provide impeccable customer service and warranties on all products that had the Feighner name, and the rest is history.

Since then, Feighner has continued to grow into a nationwide manufacturer. In 2006, Feighner Boat Lifts & Docks moved to Charlotte, MI to a much larger facility. This building was expanded upon five times since it's purchase and continues to be the main manufacturing hub. In 2020, Feighner opened a showroom and manufacturing space in Perry, MI, along the international highway, I-69. Entering into 2022, the facility has tripled in size and encompasses almost an entire acre under roof. In 2021, Feighner opened a distribution center in Gwinn, MI – conveniently located in the beautiful Upper Peninsula of Michigan.

Feighner Boat Lifts & Docks builds and markets docks and lifts all year around, not just on a seasonal basis. Feighner Boat Lifts & Docks always stands behind their products, which keeps our customers, continually coming back for new innovative boat lifts and docks and excellent service. The two Feighner Boat Lifts & Docks key components to quality are our employees and the TFC manufacturing controls.

1. Our employees are full time, and have built thousands of units before yours. They genuinely care that your new boat lift and dock is built to your satisfaction.
2. Feighner Boat Lifts & Docks controls every aspect of our manufacturing processes. TFC manufactures every part that is utilized in a Feighner boat lift and dock. Every Feighner boat lift and dock is manufactured by our employees in Michigan.

The Feighner Company is still a family corporation and would like to invite you to stop by for a tour of our facility and to meet the family and staff.



PERRY, MICHIGAN



## MAINTENANCE FREE DECKING CHOICES

SunWalk 45



BEIGE

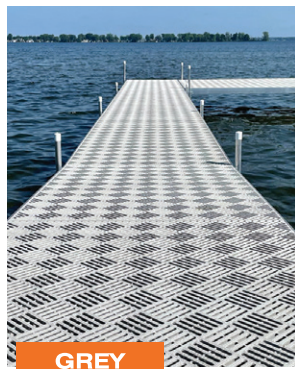

GREY

SunWalk 90



BEIGE

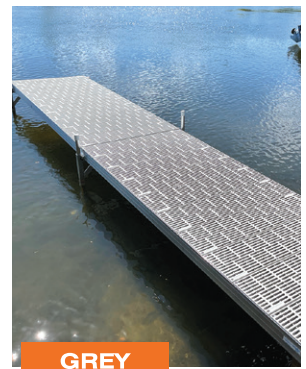

GREY

Coastal

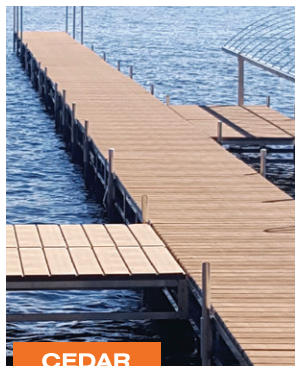

CEDAR



GREY

Recycled Plastic



MINK

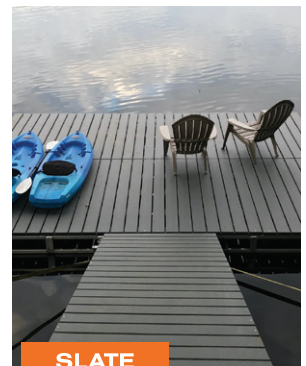

SLATE

## FEIGHNER ENGINEERED ALUMINUM PIPE

Available in two diameters for residential and commercial applications.  
8' - 10' - 12' and 20' lengths in stock

- 23% stronger than 2" steel pipe when being struck by a moving boat
- Holds 40% more load weight than 2" steel pipe





# Feighner Sectional Dock Support Options

## Classic Cross Arm



Shallow water applications, 8" sleeve, 1 set bolt

## Turn Arm



Used to make L Shape configurations

## Superior Cross Arm



Robust 16" sleeve, 2 set bolts and diagonal bracing

## T Arm



Used to make T Shape platform

## Deep Water Cross Arm



39" sleeve, 4 set bolts, recommended for 6' or more of water



Sectional Dock Supported with Superior Cross Arms





# Superior Sectional Docks

## Superior Sectional Dock Features

- Offered in a standard 4'x10'
- 16" on center offered in SunWalk 90 decking
- 12" on center offered in SunWalk 45, Coastal and Maintenance Free Recycled Plastic
- Can easily be configured straight out, an L or T shape or a platform
- Supported with our Superior Cross Arm, complete with a 16" sleeve and side bracing for added stability
- Stainless steel screws fasten decking to the frame









# Patio Docks

## SHORELINE PATIO SYSTEM

### Patio Dock Features

- Perfect area for lounging and socializing
- Generally extends 8' or 12' out into the water and stretches along the shoreline
- Easier to install than large platforms at the end of a dock
- Supported with heavy duty double box frame construction
- Ideal for parking boats parallel to the shore
- Can easily provide a shore base for a longer dock





# Adjustable Steps

## ADJUSTABLE STEPS

*Available in any size!*

**Treads are height adjustable,  
ranging from 3" to 10"**

Adjustable steps are a standard 4' tread width and comes standard with (1) handrail, (2) 2.5' pipes, (2) mud pads, (2) rubber caps and mounting hardware.

Additional handrails are available for a fee.

### **How do I know how many steps I need?**

Take your total height in inches and divide that by 8. The answer equals the minimum amount of steps required.



## ADJUSTABLE STEP DOCK

- 2 Steps
- 4 Steps
- 6 Steps

### **Adjustable Steps vs Step Dock**

Adjustable steps are used to get to the water from the top of a dock or seawall. Step Docks are used to get down, but also to extend out further in length during the descent. Often times used to get down from a very tall seawall while replacing the first section of dock.

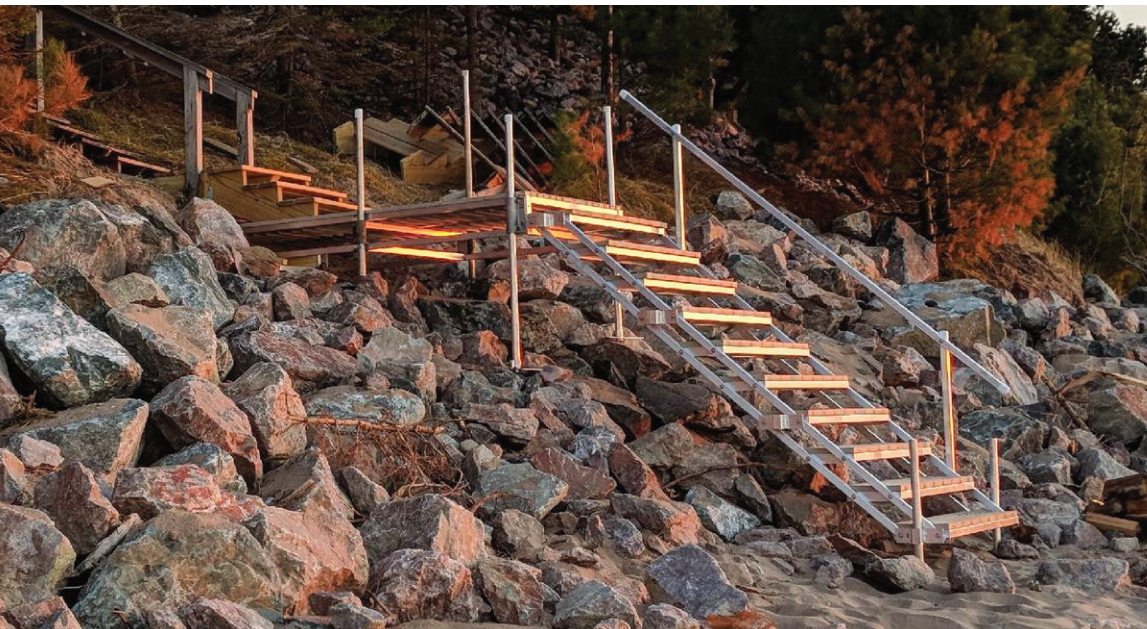

**Larger Steps  
Are  
Available  
Upon  
Request**



# Rolling Docks



Landside Wheel Kit on SunWalk 45 Grey

## Rolling Dock Features

- All Aluminum Box Tube Construction
- Full Length Center Stringers
- Standard 4' width, available in 6', 8' and 12' widths
- Strong Roller System for Smooth Height Adjustment
- Available With or Without Wheels
- Wheelchair Accessibility
- Aluminum Stand Pipes
- Modular Design for Virtually Unlimited Configuration



Rolling Dock with benches



SunWalk Rolling Dock with Ramp into Water



Stairs to Rolling Dock

## Dock to Dock Hinge Kit



Rolling Dock with gangway





SunWalk 45 Sectional with Kayak Racks



36" Bumper

Corner Bumper



Heavy-Duty Flip Up Swim Ladder w/ Hardware



Dock with Bench and Flag Pole

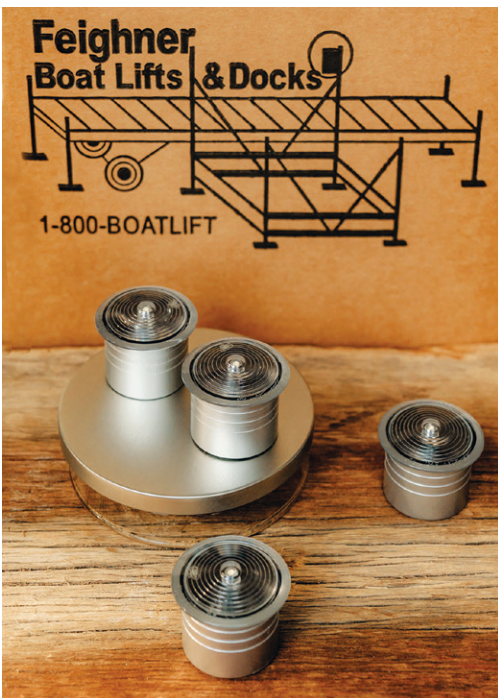

Solar Dock Dots

Available in White, Blue, Green, Yellow, Red and Magenta



Solar Lantern

Fits multiple pipe sizes



Solar Cleat





# Floating Docks

## Floating Dock Features

- Floating Docks are an excellent selection for deep or mucky waterfronts
- 6' wide dimension is ideal for going straight out
- 4' wide dimension is ideal for making wider "T" shaped or marina style slips
- Can add bolt-on handrails for safety or commercial projects
- Gangway with hinge available to transition from shore to water
- Popular for farm ponds or other areas with changing water level
- Entire structure is augered into the ground
- Weight is supported with foam filled float tanks that will not fill with water

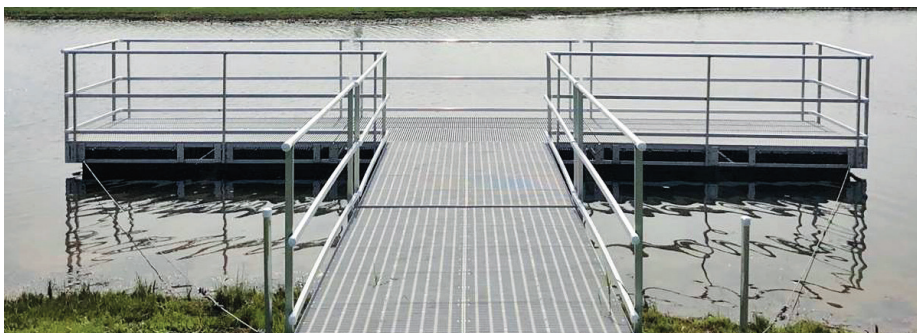



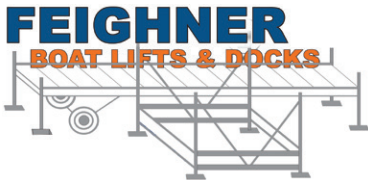

# Cable Boat Lifts

## EASY RISER II VERTICAL BOAT LIFT

### Features

- Shallow Water Design
- Total of 79.5" of Lift Height
- Triangulated Side Structure for Easy Boat Access
- Heavy Duty Slide Mechanism Keeps Bed on Track and Eliminates Binding
- Heavy Duty Chain Drive Winch
- Low Maintenance Sheaves
- Stainless Steel Connecting Hardware
- Heavy Duty Aluminum Frame Construction
- Wide Array of Accessories Including:
  - *Centering Guides and Steps*
  - *Motors*
  - *Canopies*
  - *E-Z Out Wheels*



Easy Riser II 5,500 LB. Capacity with Inboard Bunks



Easy Riser I 2,500 LB. Capacity With Regular Bunks

## EASY RISER BOAT LIFT

### Features

- Total of 74" of Lift Height
- Available in Narrower Widths
- 75 lbs. + Lighter than the Easy Riser II
- Heavy Duty Chain Drive Winch
- Low Maintenance Sheaves
- Stainless Steel Connecting Hardware
- Heavy Duty Aluminum Frame Construction
- Wide Array of Accessories Including:
  - *Centering Guides and Steps*
  - *Motors*
  - *Canopies*
  - *E-Z Out Wheels*



# Boat Lift Accessories



## E-Z Out Wheel Kit

*Includes One Axle and Two Wheels*



## Feighner Boat Lift Motor with Fob

12V/24V or 120V

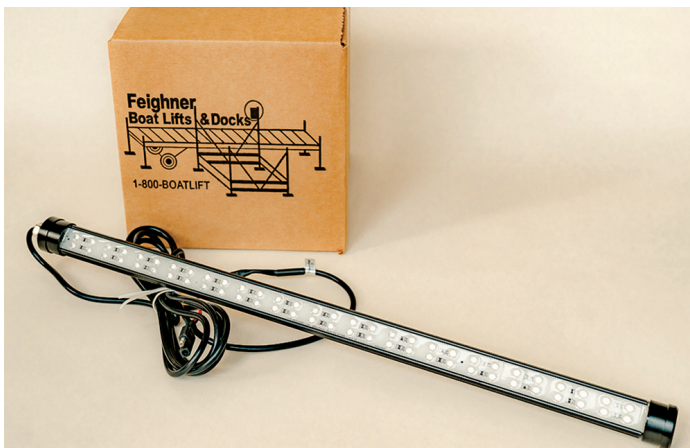

## 2' Light Bar

*Motor Required*



## Solar Panel Package

*with Mounting Bracket, Battery Box, Tray and Charger 12V | 24V*

**SEE PAGE 17  
FOR CANOPIES**



# Bunk Options

## Regular Bunks



Featured with Optional Centering Guides & Steps



Featured with Adjustable Inboard Supporting Bunk

## Inboard Bunks



## Pontoon Bunks

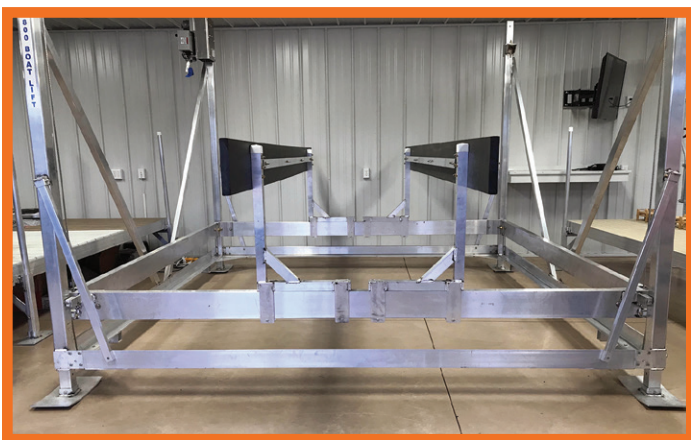

## Pontoon Rack Adaptor



## Adjustable Shallow Water Tritoon



# Build Your Own Boat Lift

## STEP 1 – Choose Your Style

### Easy Riser I Vertical Boat Lift

VERTICAL STYLE	BEAM WIDTH	LIFT HEIGHT / MOVEMENT	EST. WEIGHT
2,500 lbs. Capacity	96"	74" / 64"	300 lbs.
2,500 lbs. Capacity	108"	74" / 64"	325 lbs.

### Easy Riser II Vertical Boat Lift

VERTICAL STYLE	BEAM WIDTH	LIFT HEIGHT / MOVEMENT	EST. WEIGHT
4,000 lbs. Capacity	114"	79.5" / 70"	450 lbs.
4,500 lbs. Capacity	120"	79.5" / 70"	510 lbs.
5,000 lbs. Capacity	114"	79.5" / 70"	550 lbs.
5,500 lbs. Capacity	108"	79.5" / 70"	560 lbs.
5,500 lbs. Capacity	120"	79.5" / 70"	575 lbs.
5,500 lbs. Capacity	132"	79.5" / 70"	615 lbs.
6,500 lbs. Capacity	108"	79.5" / 70"	595 lbs.
6,500 lbs. Capacity	120"	79.5" / 70"	605 lbs.
6,500 lbs. Capacity	132"	79.5" / 70"	625 lbs.
7,000 lbs. Capacity	120"	79.5" / 70"	630 lbs.
7,500 lbs. Capacity*	120"	79.5" / 70"	680 lbs.

\*Includes Integrated Motor - 12V/24V or 120V

### Personal Watercraft / Small Boat (Includes bunks and winch wheel)

VERTICAL STYLE	BEAM WIDTH	LIFT HEIGHT / MOVEMENT	EST. WEIGHT
1,200 lbs. Capacity Cantilever	64"	36" / 32"	215 lbs.
1,200 lbs. Capacity	64"	52" / 49"	175 lbs.
1,500 lbs. Capacity	64"	74" / 64"	200 lbs.
2,500 lbs. Capacity	84"	74" / 64"	275 lbs.

## STEP 2 – Choose Your Power

Winch Wheel

12V/24V or 120V Feighner  
Boat Lift Add On Motor with Fob

12V/24V or 120V Feighner Boat Lift  
Integrated Motor with Fob

## STEP 3 – Choose Your Maintenance Free Bunks

Regular Outboard IO	Inboard 4,000 lbs. or Less	Inboard 4,000 lbs. or More	Pontoon V Bunks (12')	Pontoon V Bunks (16')	Pontoon Rack Adaptor	Adjustable Shallow Water Tritoon	Non Adjustable Shallow Water Tritoon
---------------------	----------------------------	----------------------------	-----------------------	-----------------------	----------------------	----------------------------------	--------------------------------------

## STEP 4 – Add Your Accessories

- Full Length Centering Guides & Steps
- Adjustable Inboard Supporting Bunks – *Strongly recommended for boats 4000 lbs. +*
- E-Z Out Wheels – One Pair
- 6' Leveling Legs (pair) with exchange
- 8' Leveling Legs (pair) with exchange
- Solar Light Bar
- 12V Solar Panel Package with Mounting Bracket, Battery Tray and Charge Controller
- 24V Solar Panel Package with Mounting Bracket, Battery Tray and Charge Controller

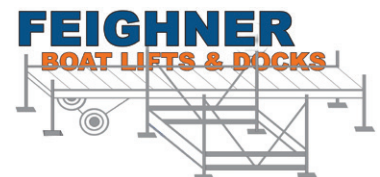





# Canopies

## Canopy Features

- Unique wrap around design for better protection
- Adjustable height options to match your boat
- Optional UV protected mesh curtains available

**Colors Available:**  
Grey, Beige, Black,  
Blue, Green, and Red

## FEIGHNER CANOPIES

*Featuring  
18 oz. Vinyl Fabric*

Canopy Bracing  
Recommended for Canopies 26'  
and in High Wind Areas



*Consider adding a  
light bar to your motor  
package to provide LED  
light inside your canopy!*





## Free Standing Canopy

### Free Standing Canopy Features

- The Feighner Free Standing Canopy is a great option for anyone who would like the coverage of a canopy but is not a candidate for a boat lift.
- In the future, if your situation changes, The Free Standing Canopy can easily be transformed into a fully operational boat lift!

*The Feighner Free Standing Canopy offers the same unique wrap-around on top of our durable free standing frame.*

*Each frame comes with leveling legs and augers to achieve the perfect fit for your site.*







# Hydro Max II

## Hydro Max II Features

- Exclusive over center hinge design prevents sagging or settling
- Includes stainless steel cylinders with chrome plated rod and stainless steel braided hoses for durability

### Shallow Water Depth Series

Capacity	Number of Hinges	Beam Width	Lift Height	Number of Cylinders	Bunk Length	Minimum Water Depth	Centering Guide Length	Hinge Dimension Inside/Outside
4,000 lbs. Capacity	2	120"	41.5"	4	10'	18"	12'	26" / 38"
5,000 lbs. Capacity	2	120"	41.5"	4	10'	18"	12'	26" / 38"
6,000 lbs. Capacity	3	120"	41.5"	4	13.5'	18"	16'	26" / 38"
8,000 lbs. Capacity	3	120"	41.5"	6	13.5'	18"	16'	26" / 38"
10,000 lbs. Capacity	4	132"	41.5"	6	18'	18"	20'	varies
12,000 lbs. Capacity	4	132"	41.5"	8	18'	18"	20'	varies

### Normal Water Depth Series

Capacity	Number of Hinges	Beam Width	Lift Height	Number of Cylinders	Bunk Length	Minimum Water Depth	Centering Guide Length	Hinge Dimension Inside/Outside
3,800 lbs. Capacity	2	120"	41.5"	2	10'	29"	12'	26" / 38"
5,800 lbs. Capacity	2	120"	41.5"	4	10'	29"	12'	26" / 38"

### Pontoon and Tritoon Series

Capacity	Number of Hinges	Beam Width	Lift Height	Number of Cylinders	Bunk Length	Minimum Water Depth	Centering Guide Length	Hinge Dimension Inside/Outside
6,000 lbs. Capacity	3	132"	53.5"	4	18'	20"	18'	varies
8,000 lbs. Capacity	3	132"	53.5"	6	18'	20"	18'	varies

### PWC Lifts Series / Twin Series

Capacity	Number of Hinges	Beam Width	Lift Height	Number of Cylinders	Bunk Length	Minimum Water Depth	Centering Guide Length	Hinge Dimension Inside/Outside
1,500 lbs. Capacity	2	60"	41.5"	2	7'	18"	12'	14" / 26"
1,500 lbs. Capacity	2	108"	41.5"	2	10'	18"	12'	26" / 38"
2,000 lbs. Capacity - TWIN	4	120"	41.5"	4	10'	18"	12'	14" / 26"

### Accessories

- Hydro Max II Canopy Extensions (8' w/Exchange for Leg Pockets – 4)
- Adjustable Full Length Centering Guides with Step – up to 5,800 lbs.
- Adjustable Full Length Centering Guides with Step – 6,000 lbs. to 8,000 lbs.
- 12V Solar Charging Panel, 10 Watt, with Mounting Bracket
- Hydraulic Box Holder – Plastic or Fiberglass
- Hydro Max II E-Z Out Wheels
- Hydro Max II Tritoon Kit (3 Pairs of Maintenance Free Bunks, Plus Additional Aluminum Supports)
- Hydro Max II Pontoon Rack Adaptor
- Side Beams – Extra – To Secure Outside Leveling Legs - Up to 8,000 lbs.



# Family Owned and Operated for 35+ Years



ACCREDITED  
BUSINESS

**SATISFACTION GUARANTEED  
ASK FOR DETAILS**



**FEIGHNER**  
BOAT LIFTS & DOCKS



**SCAN  
HERE FOR  
PRICING**



**We have three locations...**

2264 Lansing Rd.,  
Charlotte, Michigan 48813 USA  
Toll Free 1-800-BOATLIFT  
(517) 541-0900 - Fax (517) 541-0909

7829 Lansing Rd.,  
Perry, Michigan 48872 USA  
(517) 675-1100

65 Flodin Rd.,  
Gwinn, Michigan 49841 USA  
(906) 273-1411

**DEALER'S IMPRINT (COPYRIGHT 2025)**

Hours: 9:30 AM - 5:00 PM E.S.T. Weekdays  
Gwinn Location: M-W-F 9:00 AM - 12:00 PM E.S.T.  
and by Appointment

**[www.1800boatlift.com](http://www.1800boatlift.com)**